

SPECIFICATION FOR DEEP UV LED

180180 UVC LED PKG

DESCRIPTION

The BR180QF275S100X is a deep UV LED package based on brilliant aluminum reflector with a peak wavelength of 275 nm.

In the case of aluminum, the reflectivity of the UV wavelength band is the best metal.

Moreover, reliability is also excellent because the LED PKG body radiates heat as a whole.

In the case of a transparent quartz glass that protects the UV LED, the application of quartz glass maximizes the light output of the UV LED.

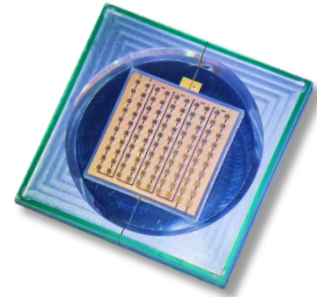

FEATURES

- Brilliant Aluminum SMT package with quartz glass
- Dimension (L x W x H) in mm
 - 18.0 x 18.0 x 1.8
- Forward current: up to 5,000 mA
- Radiant power (typ.)
 - 1,100 mW at 3,500 mA
- Viewing Angle ($2\theta_{1/2}$)
 - Typical 105°
- Built in ESD Protection device

APPLICATIONS

- Sterilization
- Disinfection
- Chemical and Biological analysis
- Phototherapy
- Fluorescent Spectroscopy
- Counterfeit Detectors
- Irradiance

Table of contents

1. PKG Specifications	3
2. Bin Structures	4
3. Typical Characteristics Graphs	5
4. Outline Dimensions	6
5. Reflow Soldering Profile	7
6. Precautions on use	8-10

1. PKG Specifications

1) Absolute maximum ratings

[Ta=25°C]

Parameters	Symbol	Value	Unit
Forward current	If	5,000	mA
Power dissipation	Pd	55	W
Operating temperature	Topr	- 40 ~ +80	°C
Storage temperature	Tstg	- 40 ~ +100	°C
Soldering temperature	Tsol	260*)	°C
ESD Classification		Class2**)	

Notes

*) Recommend JEDEC-J-STD-020D for reflow soldering.

***) The ESD test follows JESD22-A114.

2) Electrical and Optical Characteristics

[Ta=25°C]

Parameter	Symbol	If	Min	Typ	Max	Unit
Peak wavelength	λ_p	3,500mA	270	275	280	nm
Radiant Flux	Φ_e	3,500mA	800	1,100	1,300	mW
Forward voltage	Vf	3,500mA	9.0	11.0	13	V
Full Width at Half Maximum	$\Delta\lambda$	3,500mA	10.0			nm
Viewing angle	$2\theta_{1/2}$	3,500mA	105			deg

Notes

- Peak Wavelength(λ_p) Measurement tolerance is ± 3 nm.
- Radiant Flux(Φ_e) Measurement tolerance is ± 10 %.
- Forward Voltage(Vf) Measurement tolerance is ± 3 %.
- Viewing angle(deg) Measurement tolerance is ± 5 deg.

2. Bin Structures

[If=3,500mA, Ta=25°C]

Item	Bin	Min	Max	Unit
Peak Wavelength	W	270	280	nm
Radiant Flux	R1	800	900	mw
	R2	900	1,000	
	R3	1,000	1,100	
	R4	1,100	1,200	
	R5	1,200	1,300	
Forward Voltage	V1	9	10	V
	V2	10	11	
	V3	11	12	
	V4	12	13	

Notes

- Peak Wavelength(λ_p) Measurement tolerance is ± 3 nm.
- Radiant Flux(Φ_e) Measurement tolerance is $\pm 10\%$.
- Forward Voltage(V_f) Measurement tolerance is $\pm 3\%$.

3. Typical Characteristics Graphs

1) Forward Current vs. Forward Voltage

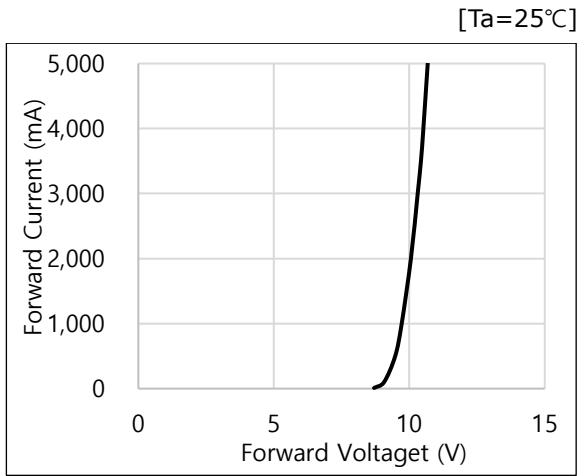

2) Relative Radiant Flux vs. Forward Current

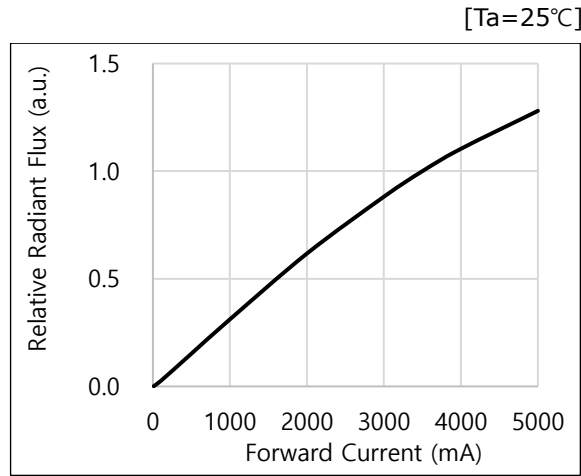

3) Peak Wavelength vs. Forward Current

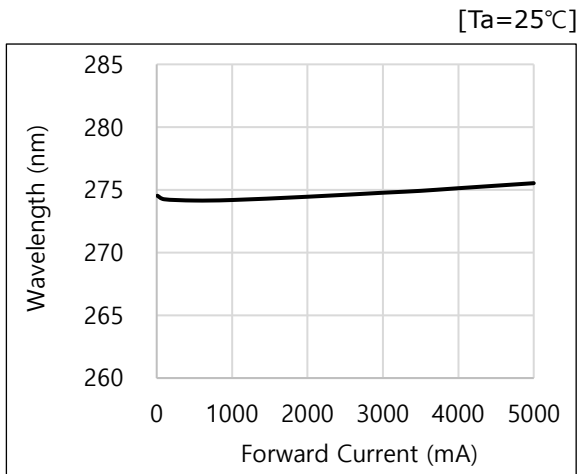

4) Ambient Temp. vs. Relative Radiant Flux

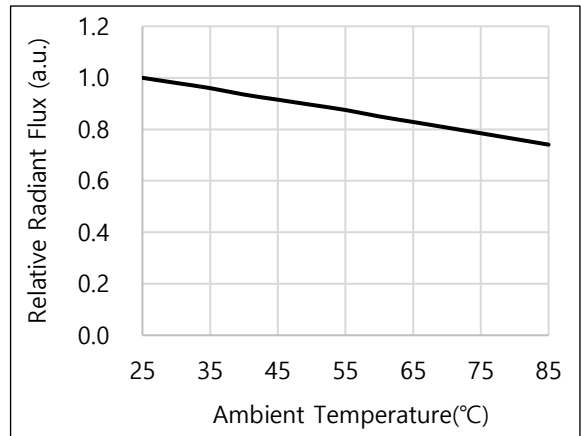

5) Spectrum

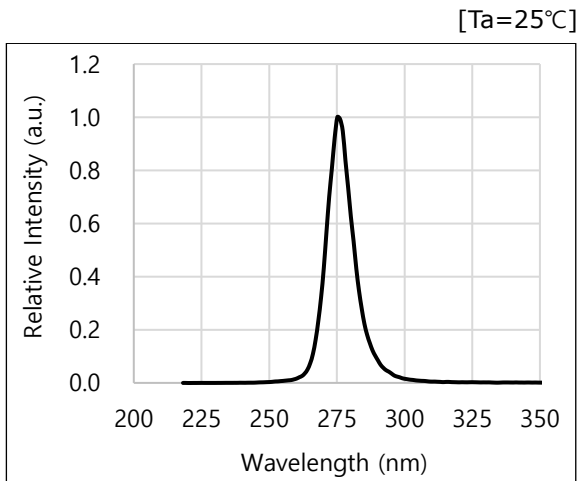

6) Typical Spatial Distribution

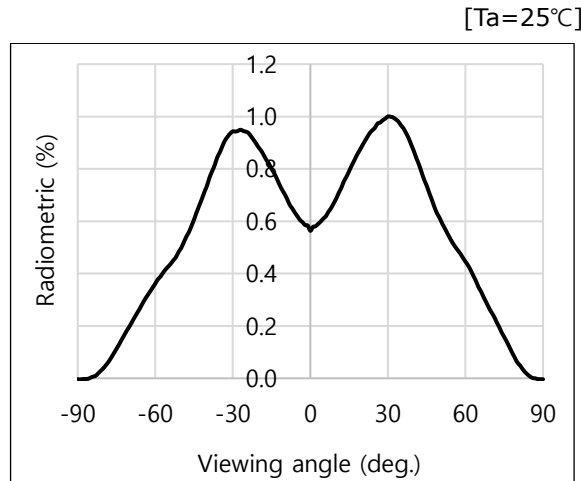

4. Outline Dimensions

1) PKG Dimensions

- PKG Dimensions - 18.0 x 18.0 x 1.8 (L x W x H)
- Undefined tolerance is $\pm 0.2\text{mm}$

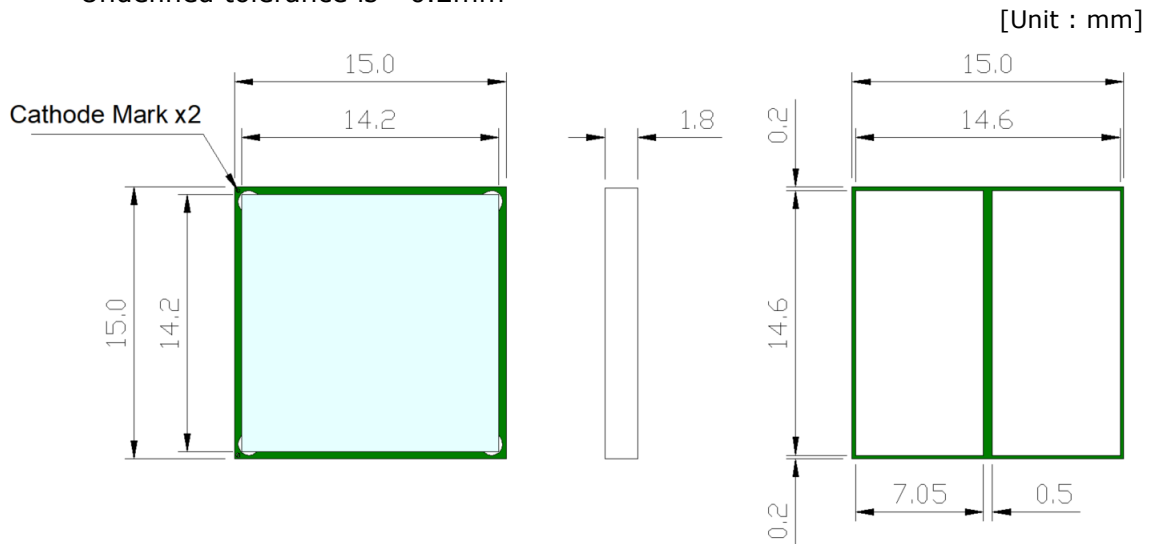

2) Recommended Solder Pad

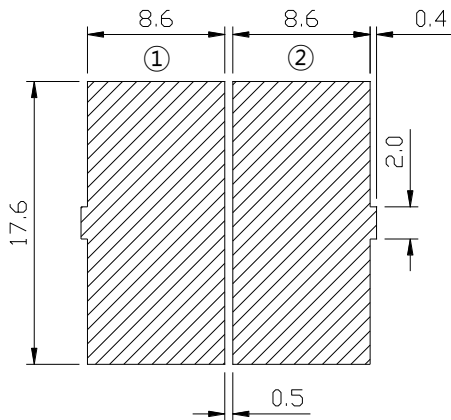

3) Recommended Stencil Pattern

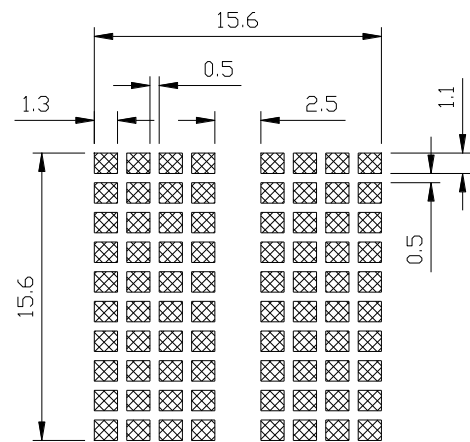

4) Internal Circuit

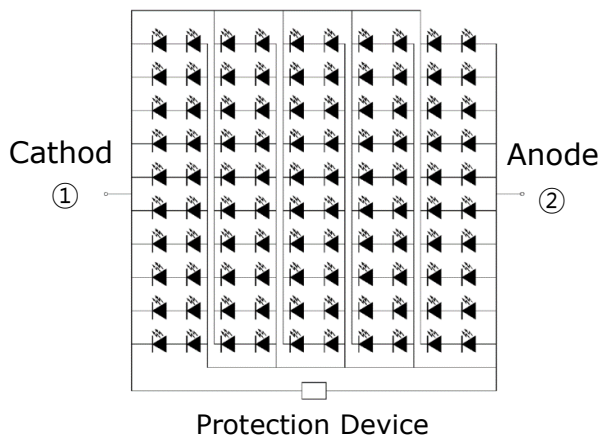

5. Reflow Soldering Profile

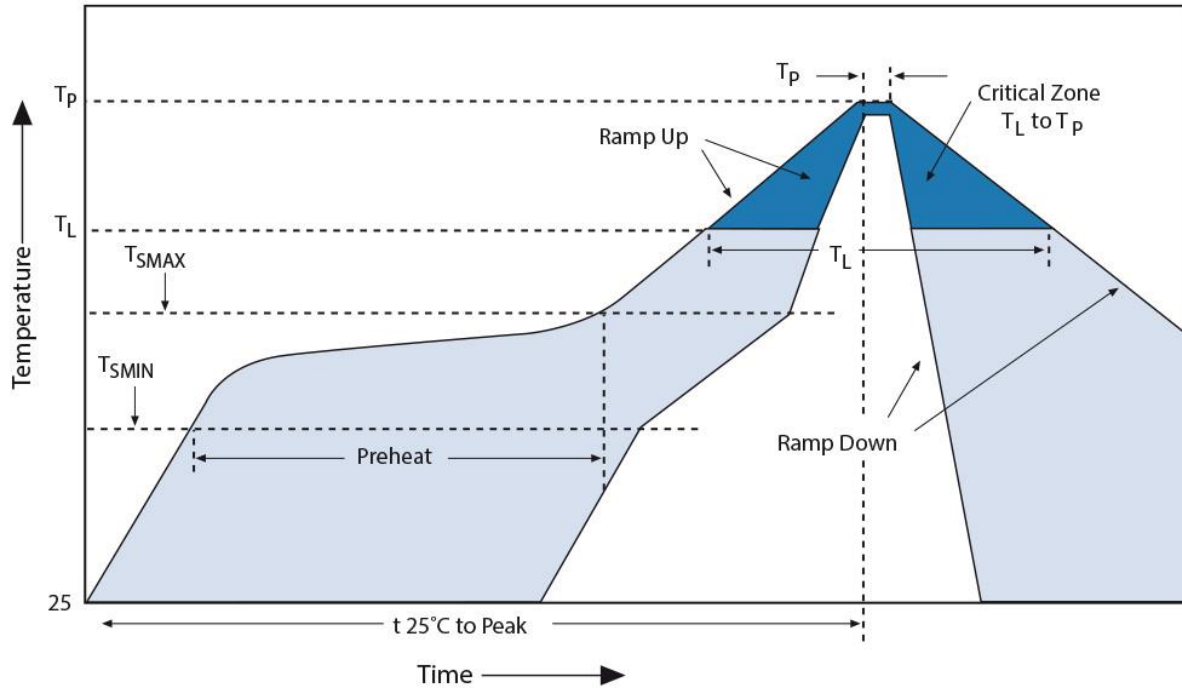

[Classification Reflow Profiles]

Profile Feature	Pb-free Assembly	Sn-Pb Eutectic Assembly
Average ramp-up rate (T _{Smax} to T _p)	3°C/second max	3°C/second max
Preheat		
- Temperature Min (T _{Smin})	150 °C	100 °C
- Temperature Max (T _{Smax})	200 °C	150 °C
- Time (T _{Smin} to T _{Smax}) (ts)	60-180 seconds	60-120 seconds
Time maintain above:		
- Temperature (T _L)	217 °C	183 °C
- Time (t _L)	60-150 seconds	60-150 seconds
Peak Temperature (T _p)	260 °C	235 °C
Time within 5°C of actual Peak Temperature (tp) ²	20-40 seconds	10-30 seconds
Ramp-down Rate	6 °C/second max	6 °C/second max
Time 25°C to Peak Temperature	8 minutes max.	6 minutes max.

Notes

- All temperature refer to topside of the package, measured on the package body surface.
- The LED package is designed to be reflow soldered to a PCB. If dip soldered or hand soldered, PEC will not guarantee its reliability.
- Reflow soldering must not be done more than two times.
- When the LED PKG is cooled at the maximum temperature, a rapid temperature fall is not recommended.

6. Precautions on use

1) Storage condition

- This LED PKG is vacuum-packed in an aluminum bag containing a dehumidifying agent. However, if the storage environment is not good, the LED PKG can absorb moisture.
- When soldering with LED PKG absorb moisture, vaporization of moisture may occur and internal air may expand. This may cause the quartz to peel off or deteriorate its optical properties.
- It is recommended to keep in the environment shown in the table below.

Conditions		Temperature	Humidity	Time
Storage	Before Opening Aluminum Bag	5°C ~ 30°C	< 50%RH	Within 1 Year from the Delivery Date
	After Opening Aluminum Bag	5°C ~ 30°C	< 60%RH	≤ 672 hours
Baking		65 ± 5°C	< 10%RH	10 ~ 24 hours

2) Circuit design

- When designing the circuit by applying the BR series, be sure to not exceed the absolute maximum ratings of each LED.
- For the BR series, it is designed to operate with forward voltage. If a reverse voltage is applied, the LED chip and the Zener diode can be damaged.
- For the current drive method, it is recommended to operate in the constant current mode.
- For Circuit, it is recommended to add additional resistors for each LED, like Circuit A. When designing as Circuit B, C, current deviations may occur due to Vf deviation of LED, which causes defects.

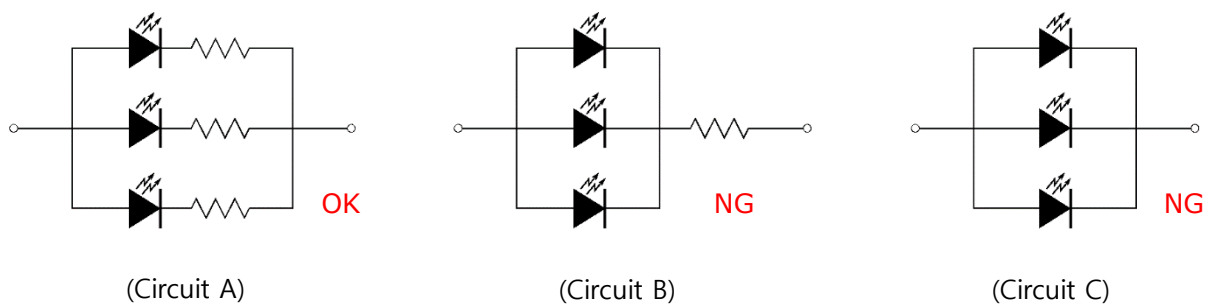

3) Handling precautions

- When handling the LED PKG using a tweezer, handle it in a direction parallel to the electrode separation line as shown in Fig. A below.
- When handling as shown in Fig. B, short-circuit failure may occur due to damage between electrode separation lines.
- When handling as shown in Fig. C, may cause quartz to break or scratch.

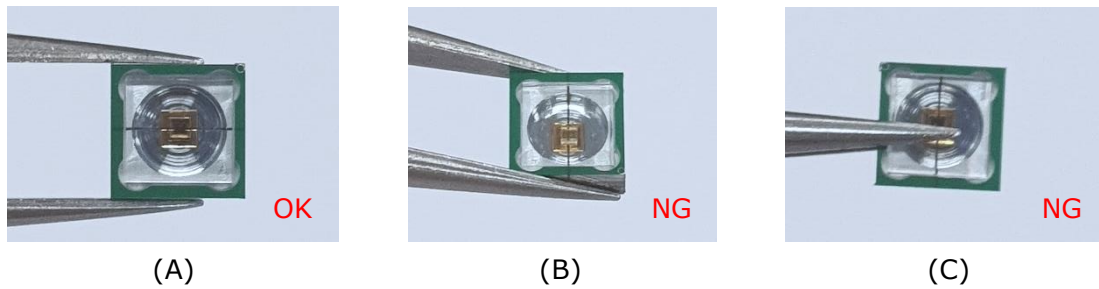

- Do not do rapid cooling immediately after soldering. It can cause the failure of the LED PKG.
- Handling the LED PKG by hand may contaminate the LED surface, which may cause the light output to drop.
- Dropping the LED PKG may cause LED damage.

4) ESD (Electrostatic Discharge)

- Use all objects and materials in the workplace for anti-static measures.
- Grounding
 - ① All instruments, JIG, and equipment in the workplace should be grounded and measured once a month by a ground resistance meter.
 - ② Workers should wear antistatic clothing and ground through a wrist strap or heel ground. Earth ring should be connected so as not to be shaken when grounding, and check for disconnection every day.
- The working surface of the work table is provided with a conductive mat and grounded. Periodically measure and check the conductivity state.
- The work table preferably has a surface resistance of 10^5 to 10^9 [Ω /SQ], and the metal work table is not good. (Breakage due to rapid discharge)
- Install conductive tiles or mats and regularly measure and manage grounding resistance and static electricity.
- Partially high static electricity is generated such as rotating body, TV, monitor, JIG. If it is non-conductive, use ionizer or anti-static spray regularly and prevent static electricity.

- In addition to general cases, use humidity control or partial humidifier to suppress the generation of static electricity.

5) Thermal Management

- Thermal management is closely related to the lifetime of LEDs.
- The temperature of the LED during operation must not exceed the junction temperature (T_j).
- For temperature management of the LED, the thermal resistance of the PCB and the spacing between the LEDs must be considered.
- For PCBs, a Cu based metal PCB is recommended, and if necessary, a heat sink should be attached to manage the LED temperature.

6) Eye Safety

- This UV LED PKG emits high power UV light.
- Exposure to light with strong UV light can cause damage to the human eye and skin.
- Do not look directly or indirectly at UV light.
- If exposure to UV light is unavoidable, the body should be protected by suitable protection devices such as goggles and clothing.
- Attach the following warning labels on products/systems that use UV LEDs.

